

RINNENERWEITERUNG INNENECKFORM - HALBRUNDE RINNE

Art.-Nr.:	61683
Nenngröße [mm]:	280/80
Material:	Kupfer
Ablaufleistung[l/s]:	2,6

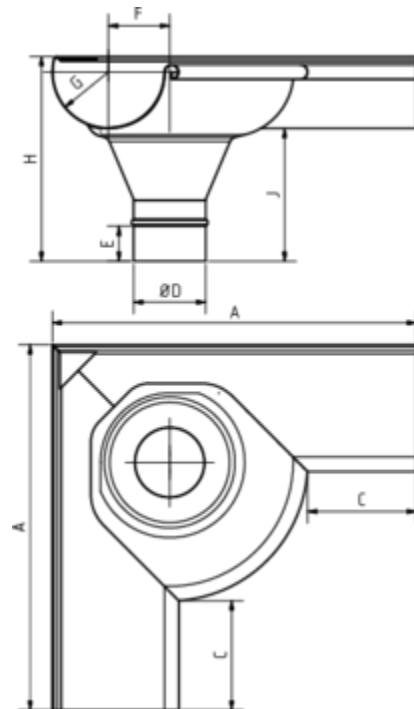

Maße [mm]:

A	C	D	E	F	G	H	J
500	190	79	48	80	63	260	250