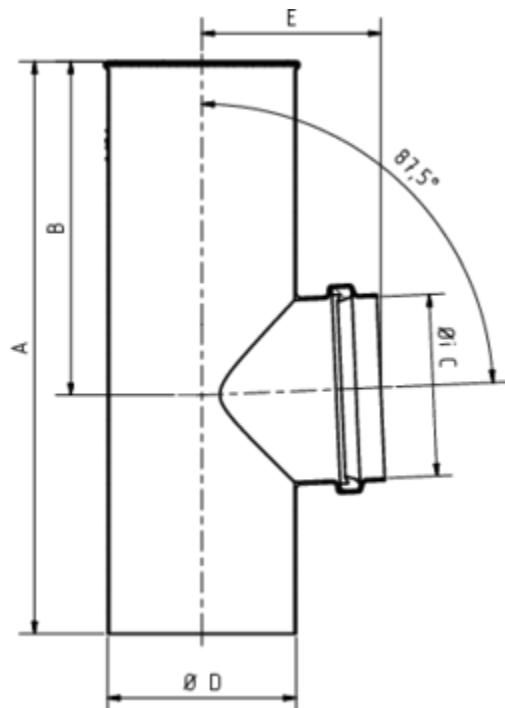

FLACHDACH-ABZWEIG

Art.-Nr.: 84240
Nenngröße [mm]: 75/80
Material: Aluminium

**Maße [mm]:**

A	B	C	D	E
240	140	76	79	75

Hinweis:

Lieferung inkl. vormontierter Zulaufdichtung