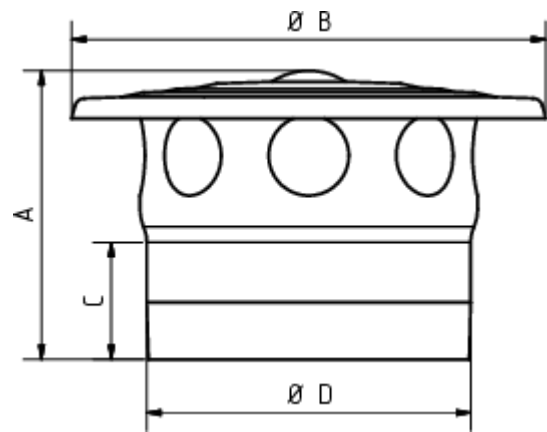

DUNSTHUT

Art.-Nr.: 62762
Nenngröße [mm]: 76
Material: Zink

**Maße [mm]:**

A	B	C	D
84	142	34	73

Hinweis:

Lüftungsquerschnitt 36 cm²