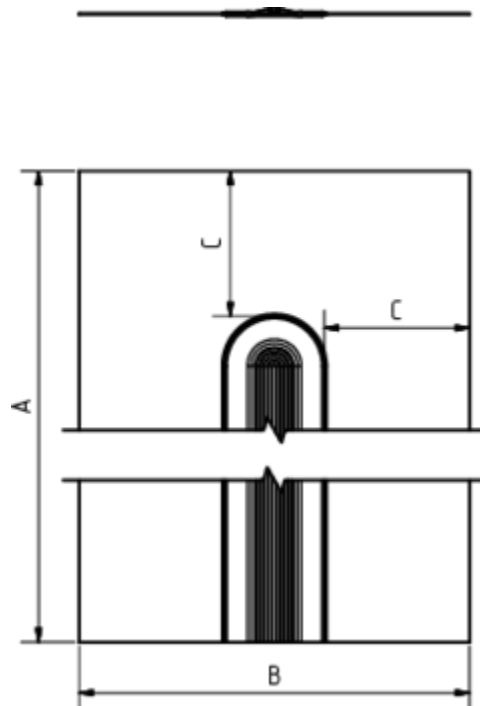
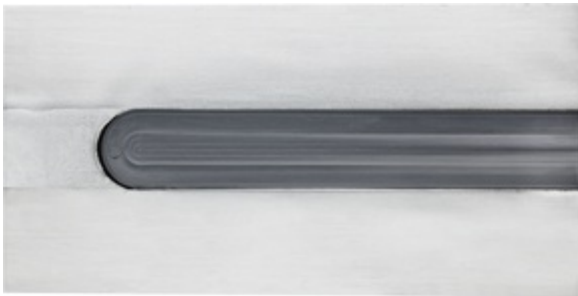

**EIN-KOPF-DILATATION**

**Art.-Nr.:** 56325  
**Nenngröße [mm]:** 390/700  
**Material:** UGINOX Patina K41

**Maße [mm]:**

A	B	C
700	390	145

**Hinweis:**

Doppelseitig vulkanisiert