

RINNENERWEITERUNG SEGMENTFORM - HALBRUNDE RINNE

Art.-Nr.:	61687
Nenngröße [mm]:	333/100
Material:	Kupfer
Ablaufleistung[l/s]:	4,5

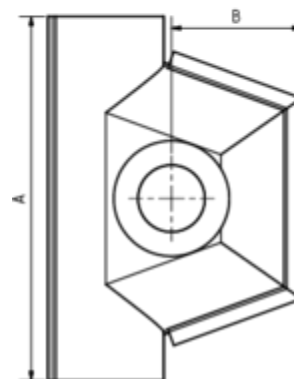
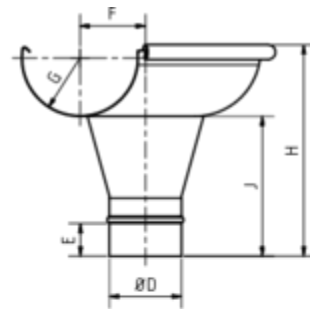

Maße [mm]:

A	B	D	E	F	G	H	J
500	180	99	45	90	80	290	192