

RINNENERWEITERUNG INNENECKFORM - HALBRUNDE RINNE

Art.-Nr.:	61685
Nenngröße [mm]:	400/120
Material:	Kupfer
Ablaufleistung[l/s]:	7,4

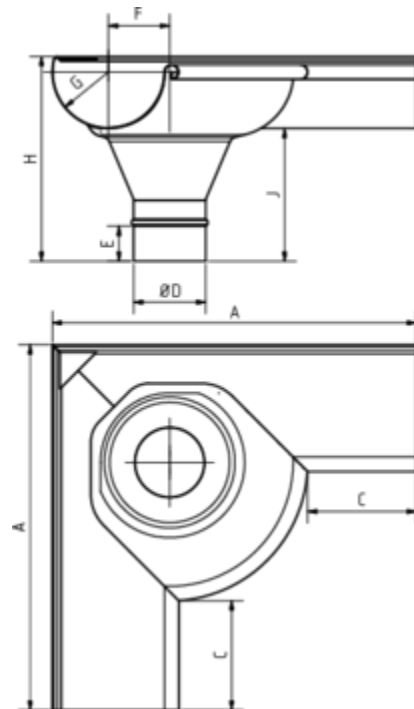

Maße [mm]:

A	C	D	E	F	G	H	J
500	75	119	48	100	95	330	320